

Thermal & Optical Bi-spectrum Bullet Camera

GLDTB-A4010/400 4MP/1080P dual camera (Optisk **6mm**/Therm **10mm**) (vare nr. 22660)

GLDTB-A4025/400 4MP/1080P dual camera (Optisk **12mm**/Therm **25mm**) (vare nr. 22661)

GLDTB-A4035/400 4MP/1080P dual camera (Optisk **12mm**/Therm **35mm**) (vare nr. 22662)

Performance series 400x300 Pixel



GUARDEON

THERMAL CAMERA SERIES

3 LEVELS OF PERFORMANCE. ONE CLEAR CHOICE.

ULTIMATE SERIES

640 x 512

HIGHEST RESOLUTION. MAXIMUM DETECTION.

PERFORMANCE SERIES

400 x 300

OPTIMAL BALANCE. RELIABLE PERFORMANCE.

ESSENTIAL SERIES

256 x 196

ESSENTIAL PROTECTION. EXCELLENT VALUE.

VISUETT KAMERA 06/05/2026 22:14:37

TERMISK KAMERA 06/05/2026 22:14:37 Termisk temperatur

NDA A COMPLIANT

MEETS U.S. GOVERNMENT REQUIREMENTS

Features Performance series

- ✓ **Thermal & optical dual** spectrum image, dual video with single IP address, adaptable to more various scenes
- ✓ CMOS 1/2.7" target surface, high sensitivity sensor, satisfy the need of **Luna** image.
- ✓ Max **4.0MP** 2688x1520@30fps optical
- ✓ Max. **1080P 400x300@30fps** thermal
- ✓ **NDAA & NIS2** compliant
- ✓ Thermal support fire detection, smoking detection and fire shield area
- ✓ Thermal module supports temperature detection and cold & hot spot tracking which highlights the abnormal temperature, and links to alarm
- ✓ Thermal & optical dual smart AI edge intrusion prevention: cross line, enter area, leave area, intrusion each camera lens
- ✓ Optical module supports smog recognition, which can help with fire alarm reconfirm
- ✓ Support picture in picture mode, real time contrast live, more convenient and clearer
- ✓ Support audio and light alarm, with red and blue warning lights built in
- ✓ Ultra 265, H.265, H.264, MJPEG
- ✓ **ONVIF**: S, G, T, M
- ✓ API, SDK
- ✓ Alarm: 3 in and 2 out, Audio: 2 in and 1 out
- ✓ MicroSD, up to 512 GB
- ✓ 5 streams
- ✓ 35 simultaneous streams (multi stream)
- ✓ IP67 Weatherproof
- ✓ **Nema 4X** coating for use in harsh environments (offshore, harbor, extreme weather, chemical, food areas)



Specifications

| Channel | Optical | Thermal |
|-----------------------------|---|--|
| Camera | | |
| Sensor | 1/2.7" CMOS LUNA | Vanadium oxide uncooled focal plane arrays |
| Max Resolution | 4 MP | 1080P |
| Original Resolution | N/A | 400 × 300 pixel |
| Min. Illumination | Color: 0.005 lux (F1.6, AGC ON) B/W: 0.003 lux (F1.6, AGC ON) 0 lux with IR light | N/A |
| Day/Night | IR-cut filter with auto switch (ICR) | N/A |
| Original Resolution-Thermal | N/A | 400x300 pixel |
| Pixel Size | N/A | 12 μm |
| NETD | N/A | < 30 mk @ F1.0 @ 25 °C |
| Shutter | Auto/Manual, 1 to 1/100000 s | |
| WDR | 120 dB | |
| S/N | >56 dB | |
| Case Type | Bullet | |
| | | |

| Optical Lens | Thermal lens | | | | | |
|---------------------------|--------------|-------|-------|---|-------|------|
| Focal Length | 6 mm | 12 mm | 12 mm | 10 mm | 25 mm | 35mm |
| Iris | F1.6 | F1.6 | F1.6 | F1.0 | F1.0 | F1.0 |
| Field of View (H) | 49.4° | 24.5° | 24.5° | 30.0° | 10.9° | 7.7° |
| Field of View (V) | 27.2° | 13.9° | 13.9° | 22.9° | 8.3° | 5.8° |
| Field of View (D) | 60.5° | 30.1° | 30.1° | 36.9° | 13.4° | 9.1° |
| DORI OPTICAL | | | | | | |
| DORI Distance (Detect) | 135 m | 270 m | 270 m | See: DRI Description for Thermal | | |
| DORI Distance (Observe) | 54 m | 108 m | 108 m | N/A | | |
| DORI Distance (Recognize) | 27 m | 54 m | 54 m | See: DRI Description for Thermal | | |
| DORI Distance (Identify) | 13.5 m | 27 m | 27 m | See: DRI Description for Thermal | | |

DORI Description for optical

Detection, **O**bservation **R**ecognition, and **I**dentification distances.

WHAT IS DORI & HOW TO USE IT IN CCTV

In the world of CCTV, **DORI** stands for **D**etection, **O**bservation, **R**ecognition and **I**dentification.



DETECTION -
The detection level allows for reliable and easy determination of whether a person or vehicle is present.



OBSERVATION -
The observation level gives characteristic details of an individual, such as distinctive clothing, while allowing a view of activity surrounding an incident.



RECOGNITION -
The recognition level determines with a high degree of certainty whether an individual shown is the same as someone that has been seen before.



IDENTIFICATION -
The identification level enables the identity of an individual beyond a reasonable doubt.



DETECTION | Person detected
Presence confirmed



OBSERVATION | Details visible
Clothing, activity, surroundings



RECOGNITION | Individual recognizable
Can be matched to a known person



IDENTIFICATION | Identity confirmed
Beyond reasonable doubt

DRI Description for Thermal

Detection, Recognition, and Identification distances according to Johnson's Criteria.

GUARDEON

DRI WITH THERMAL CAMERA

BASED ON JOHNSONS DRI METHOD



JOHNSONS DRI EXPLAINED

Johnson's DRI is a widely accepted methodology for defining performance levels for thermal imaging systems.

D - DETECTION
1.5 pixels / meter



- + Detects the presence of a person or vehicle.
- + No details, only a heat signature.
- + Used for wide area surveillance.

R - RECOGNITION
6 pixels / meter



- + Determines the type of object.
- + Person, vehicle, animal, etc.
- + Allows assessment of behavior and activity.

I - IDENTIFICATION
12 pixels / meter



- + Identifies the individual with high certainty.
- + Facial features and unique characteristics visible.
- + Used for evidence and forensic purposes.

EXAMPLE WITH 400 x 300 PIXEL THERMAL CAMERA (25mm LENS)

DETECTION DISTANCE (D)

1,000 m
1.5 pixels / meter

RECOGNITION DISTANCE (R)

250 m
6 pixels / meter

IDENTIFICATION DISTANCE (I)

120 m
12 pixels / meter

DRI Range Table Thermal Performance series (400x300 pixel)

| Thermal Lens | Detection Vehicles: 4.0 x 1.4 m | Detection Humans: 1.8 x 0.5 m | Recognition Vehicles: 4.0 x 1.4 m | Recognition Humans: 1.8 x 0.5 m | Identification Vehicles: 1.4 x 4.0 m | Identification Humans: 1.8 x 0.5 m |
|--------------|------------------------------------|----------------------------------|--------------------------------------|------------------------------------|---|---------------------------------------|
| 10 mm | 750 m | 370 m | 200 m | 100 m | 130 m | 60 m |
| 25 mm | 1900 m | 950 m | 490 m | 240 m | 330 m | 160 m |
| 35 mm | 2500 m | 1250 m | 690 m | 340 m | 460 m | 230 m |

Smart Function Table (Thermal) Smart AI

| Thermal Lens | SIP Detection Vehicles: 4.0 x 1.4 m | SIP Detection Humans: 1.8 x 0.5 m | Fire Detection target: 0.1x 0.1 m | Smoking target: (cigarette butt) | Temperature target: 0.1m x 0.1m |
|--------------|--|--------------------------------------|--------------------------------------|-------------------------------------|------------------------------------|
| 10 mm | 42 meters | 21 meters | 9 meters | 1 meter | 3.5 meters |
| 25 mm | 60 meters | 30 meters | 13 meters | 2 meters | 8 meters |
| 35 mm | 140 meters | 70 meters | 29 meters | 5 meters | 20 meters |

| Illuminator | | |
|----------------------------------|---|---|
| Wavelength IR | 750 nm | N/A |
| Illumination Distance (IR) | 50 meters - 6 and 10mm version 100 meters - 12 mm models | N/A |
| Light On/Off Control | Auto/Manual | N/A |
| Video | | |
| Frame Rate | 4.0 MP (2688 x 1520), Max 30fps | 1080P (400x300), Max 30fps |
| Video Compression | Ultra 265, H.265, H.264, MJPEG | |
| Video Bit Rate | 128 Kbps to 16 Mbps | |
| U-code | Support | |
| ROI | Support | |
| Video Stream | 5 streams | |
| Simultaneous streams | 35 | |
| OSD | Up to 10 OSDs | |
| Privacy Mask | Up to 8 areas (8 blacks/ 8 mosaics) | N/A |
| Image | | |
| White Balance | Auto, Outdoor, Fine Tune, Sodium Lamp, Locked, Auto2 | N/A |
| Digital Noise Reduction | 2D/3D DNR | |
| Flip | Normal, Flip Vertical, Flip Horizontal, 180° | |
| HLC | Support | N/A |
| BLC | Support | N/A |
| Defog | Digital Defog | N/A |
| Palette-Thermal | N/A | white hot, lava, iron oxide red, hot iron, medical, arctic, rainbow 1, rainbow 2, rainbow 3, depict hot, ice hot, black hot, mazarine, fusion, red hot, green hot, color 1, color 2, rain, puce |
| Low Illumination Characteristics | LUNA | |

| Intelligent AI edge | | |
|-------------------------------|--|--|
| AI Smart Intrusion prevention | Cross line detection, intrusion detection, enter area detection, leave area detection (support false alarm filtering and the classification of human, non-motor vehicle and vehicle) | Cross line detection, intrusion detection, enter area detection, leave area detection (support false alarm filtering and the classification of human and vehicle) |
| Temperature Range | | -20 °C to 150 °C |
| Temperature Detection-Thermal | N/A | Thermal channel supports rule-based temperature measurements. Supports real-time display of the highest, lowest, and average temperatures in the rule defined area on the screen |
| Smoking Detection-Thermal | N/A | Thermal channel supports the detection of smoking behavior in the environment |
| Events | | |
| Fire Detection | N/A | Support |
| Basic Detection | Motion Detection, Tampering Alarm, Audio Detection | N/A |
| General Function | Watermark, IP Address Filtering, Access Policy, ARP Protection, RTSP Authentication, User Authentication, HTTP Authentication, Alarm Input, Alarm Output | |
| Audio | | |
| Audio Compression | G.711U, G.711A | |
| Audio Bitrate | 128 Kbps | |
| Two-way Audio | Support | |
| Suppression | Support | |
| Sampling Rate | 16KHZ | |
| Storage | | |
| Edge Storage | MicroSD, up to 512 GB | |
| Network Storage | ANR | |
| Network | | |
| Protocols | IGMP, RTP, SMTP, IPv4, IPv6, ICMP, ARP, TCP, UDP, DHCP, PPPoE, RTSP, RTCP, RTMP, DNS, DDNS, NTP, FTP, UPnP, HTTP, HTTPS, 802.1x, SNMP, QoS, SSL/TLS, SSH | |
| Compatible Integration | ONVIF (Profile S , Profile G , Profile T , Profile M), API, SDK | |
| User/Host | Up to 32 users. 3 user levels: administrator, common user and operator | |
| Web. Client & App & software | APP: GuardEye, GuardTool Software: Guardeon VMS lite, Guardeon IP tool & Guardeon Player | |
| Web Browser | Plug-in required live view: IE 10+, Chrome 45+, Firefox 52+, Edge 79+ | |

| Interface | |
|---------------------|---|
| Built-in Mic | Support |
| Built-in Speaker | Support |
| Audio I/O | 2 inputs: impedance 1 k Ω , amplitude 2.5 V [p-p], 1 output: impedance 600 Ω , amplitude 2 V [p-p] |
| Alarm I/O | 3/2 |
| Serial Port | 1 x RS485 interface |
| Network | 1 x RJ45 10 M/100 M Base-TX Ethernet |
| Video Output | N/A 1 BNC (For debugging) |
| Certification | |
| EMC | CE-EMC (EN 55032: 2015+A1:2020, EN 61000-3-3: 2013+A1: 2019, EN IEC 61000-3-2: 2019+A1: 2021, EN 50130-4:2011+A1:2014) FCC (FCC CFR 47 part15 B, ANSI C63.4-2014) |
| Safety | CE LVD (EN IEC 62368-1:2020+A11:2020) UL (UL 62368-1, 2nd Ed., Issue Date: 2014-12-01) |
| Environment | CE-RoHS (2011/65/EU;(EU)2015/863); WEEE (2012/19/EU); Reach (Regulation (EC) No 1907/2006) |
| Protection | IP67 (IEC 60529:1989+AMD1:1999+AMD2:2013) NEMA 4X |
| General | |
| Power | DC12V (\pm 25%), PoE (IEEE802.3at) |
| Power Consumption | Max 22,4 watt |
| Power Interface | \varnothing 5.5 mm coaxial power plug |
| Dimensions | 406.0 x 130.0 x 130.0 mm (L x W x H) |
| Weight | 2.14 / 2.18 / 2.23 kg |
| Working Environment | -40 °C to 70 °C, Humidity: \leq 95% RH (non-condensing) |
| Storage Environment | -40 °C to 70 °C, Humidity: \leq 95% RH (non-condensing) |
| Surge Protection | 6 KV |
| Reset Button | Support |
| RTC | Support |
| Web Client Language | 22 Languages: Traditional Chinese, English, Simplified Chinese, Polish, German, Russian, French, Korean, Dutch, Czech, Portuguese (Europe), Portuguese (Brazil), Japanese, Thai, Turkish, Spanish (Latin America), Spanish (Europe), Hungarian, Italian, Vietnamese, Arabic, Slovak |

Live View

| | |
|----------------------|---------|
| Maximum Bitstream | 35 |
| Maximum Bandwidth | 50 Mbps |
| Plugin Free | Support |
| OSD Font | Vector |
| OSD Color | Support |
| OSD Character Number | 40 |
| 3D Privacy Mask | N/A |



Other

| | |
|---------------|---------|
| Corridor Mode | Support |
|---------------|---------|

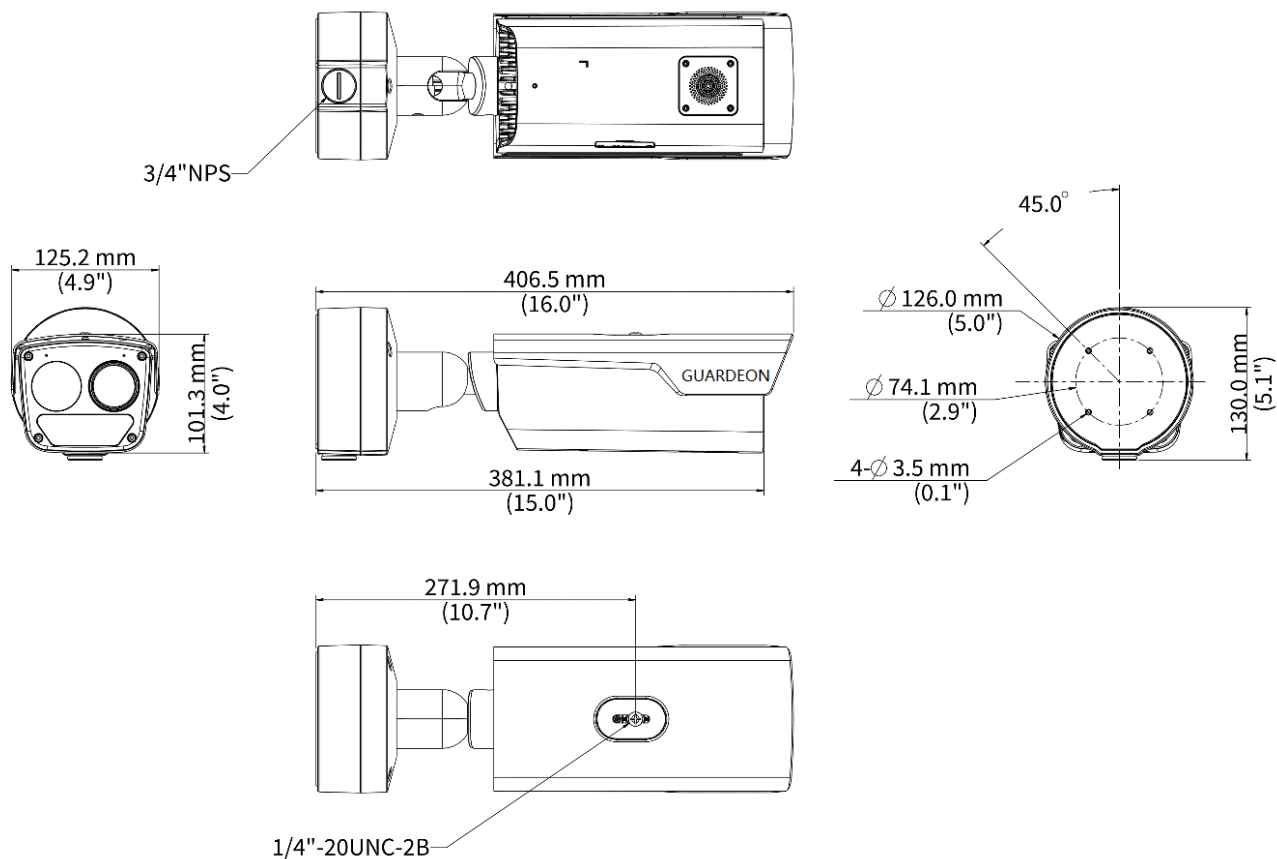
Dimensions



Accessories

| GB-137MB polemount | GBD-137HB wall/corner bracket |
|---|--|
| White alu | White alu |
|  |  |
| Varenr. 22928 | Varenr. 22921 |

* Product specifications and availability are subject to change without notice.

* Despite our best efforts, technical or typographical errors may exist in this document. Gardeon Security Systems cannot be held responsible for any such errors and reserves the right to change the contents of this document without prior notice.

